

A306-28 MASSAGE CHAIR

OPERATION INSTRUCTIONS

SAVE THESE INSTRUCTIONS

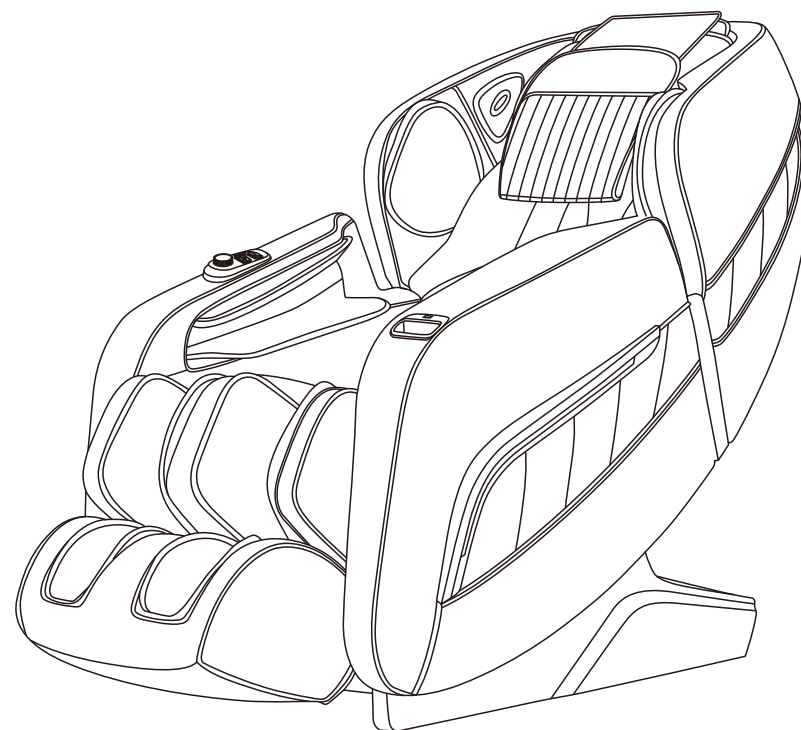

Thanks for purchasing this product. Please read this manual instruction carefully in order to know how to use this product correctly before operation. Please pay more attention to some important safety warning and keep this manual book properly for future use.

Note: Our company reserves the right to change and explain the design of the product. If there is some difference between the product function in market circulation and the description in the manual, it is a normal update of the product, and our company will not inform you otherwise. The specific product function and color shall prevail in kind.

TABLE OF CONTENTS

Safety and Maintenance	02
Safety Warning	04
Names of Components	06
Function	07
Method of Usage	08
Legal notices	20
Product Specification	21

Safety and Maintenance

1. Important Safety Warnings

- Do not allow children to touch any movable part of this product.
- Use the well-grounded power supply unit suitable for this product.
- Pull out the plug after use or before cleaning to avoid any physical injury or damage to the product.
- Operate this product as instructed in this manual.
- Do not use any parts or accessories which are not recommended.
- Do not use this product outdoors.
- Please read the Operation Instructions carefully before operation.
- Never use this product for any other purpose not listed herein.
- 20 minutes of usage each time is recommended.
- Do not use this product if the leather is broken or damaged.
- Do not use this product if the cover or leather is broken or damaged.
- Do not use this product if the radiator hole is covered or blocked.
- Do not drop anything into this product.
- Never fall asleep while using this product.
- Do not use this product if you are drunk or feel unwell.
- Do not use this product within one hour after a meal.
- Do not use this product with excessive force to avoid any injury.
- Do not carry any fragile, explosive, or combustible material in your pocket, such as a mobile phone and lighter when using the massage chair.

2. Operating Environment

- Do not use this product in a very moist environment such as the bathroom.
- Stop using this product immediately when the ambient temperature changes sharply.
- Do not use this product in any heavily-dusty or caustic environment.
- Do not use this product in a small space or a place without good ventilation.
- The normal room temperature ranges from 0 °C to 35 °C.
- Do not use this product in an excessively humid room such as a bathroom. Use it at a relative humidity between 20% and 80%.
- Do not use this product outdoors.
- Avoid direct sunlight.
- Keep this product away from any heat source such as a stove and air outlet of an air conditioner.
- Do not use this product during thunder or lightning weather.
- Do not use this product in dusty places.

3. The following populations should not use this product

- Patients with osteoporosis.
- Patients with heart disease or wearing electronic medical devices such as a pacemaker.
- People who have a fever.
- Pregnant women or women on their menstrual period.
- Patients who are injured or have a skin disease.
- When unsupervised, any children are under the age of 14 and those unconscious are not allowed to use this product.
- People who are told by their physicians to have rest or who feel unwell.
- People whose bodies are wet are forbidden to use this product.
- This product has a hot surface. Persons insensitive to heat must pay attention when using this product.

Safety and Maintenance

4. Safety Precautions

- Check whether voltage is consistent with the specification of this product.
- Never insert or pull out the plug with a wet hand.
- Do not let water flow into this product to avoid electric shock or cause damage to this product.
- Do not pull the power cord when plugging or unplugging it. Rough handling is forbidden.
- Do not damage the wire or modify the circuit of this product.
- Do not clean live parts of this product with a wet cloth such as a power switch and plug.
- Be away from this product in case of power failure to avoid any injury if power is restored suddenly.
- Stop using this product at once while it works abnormal, and consult your local supplier.
- Stop using this product if you feel unwell, and consult your health care practitioner.
- This product is not intended for use by persons (including children) with reduced physical, sensory or mental capabilities, or lack of experience and knowledge, unless they have been given supervision or instruction concerning the use of this product by the personnel responsible for their safety. Children should be supervised to ensure that they do not play with this product.
- If the power cord is damaged, it must be replaced by the manufacturer, its service agent or similarly qualified staff in order to avoid hazards.

5. Product Service and Maintenance

- This product should be maintained by the service center designated by the manufacturer only. No user should disassemble or maintain it without permission.
- Do not forget to turn off the main power switch after usage.
- Do not use this product if the power socket becomes loose.
- If this product will be left unused for a long period of time, it is necessary to roll up the power cord of this product and store this product in a dry and dust-free environment.
- Do not store this product at a high temperature or near open flame. Avoid prolonged exposure to direct sunshine.
- Please clean this product with dry cloth. Never use thinner, benzene or alcohol.
- The mechanical components of this product are specially designed and manufactured, so no special maintenance is needed.
- Do not use a sharp object to stab at this product.
- Do not roll or pull this product on any uneven ground. Instead, it should be lifted before moving.
- Please use this product intermittently. Do not keep it working continuously for a long period of time.

6. Solutions to Ordinary Malfunctions

- If the motor sounds during operation of this product, this is the normal operation sound.
- If the controller cannot work normally, check whether the plug and the power socket are connected reliably, and whether the power switch is turned on.
- If the rated working time is over, this product will automatically activate the power-off button; If this product keeps operating for a long period of time, the temperature protector will stop this product automatically. The product can be used again after half an hour.

7. Storage Conditions

- Storage room temperature: -5 °C to 35 °C.
- Relative humidity (RH) between 20% and 80%; free of corrosive gases, and a well-ventilated room.

Safety Warning

⚠ Warning

When the legrest of the massage chair is lifted, nobody should apply pressure on the legrest to prevent the massage chair from falling forward which will damage this product or result in personal injuries.

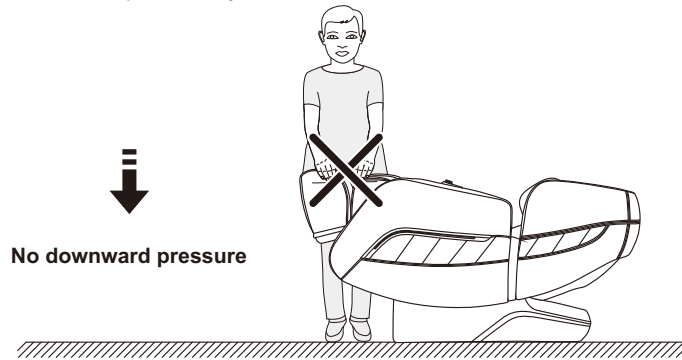

⚠ Warning

Before sitting on the massage chair, make sure that the massage chair manipulator does not stay in the seat cushion position to avoid discomfort to the buttocks during the body pressing down and any damage to the massage chair manipulator.

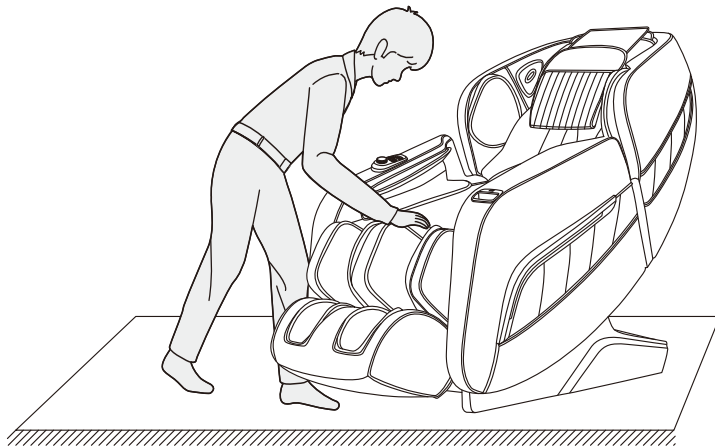

Safety Warning

⚠ Warning

Do not remove or pull out the remote controller cable or the power cord in the standby or power-on state to avoid any damage to this product or accidental electric shock of a body part. You are advised to unplug the remote controller cable and the power cord and put them away after you use the massage chair.

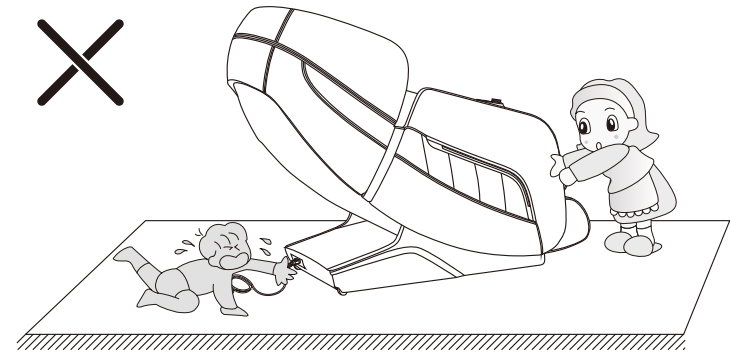

⚠ Warning

When the zero-gravity lying function is enabled, be sure to check whether there is any child or pet staying or playing under the bottom of the legrest and backrest, in order to avoid any damage to this product or physical injury.

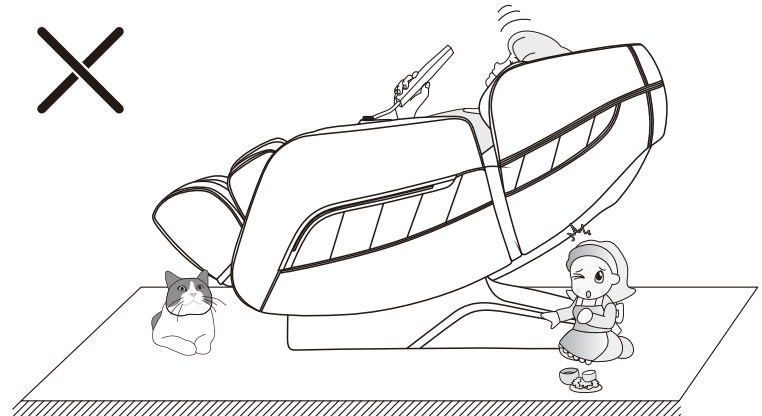

Name of Components

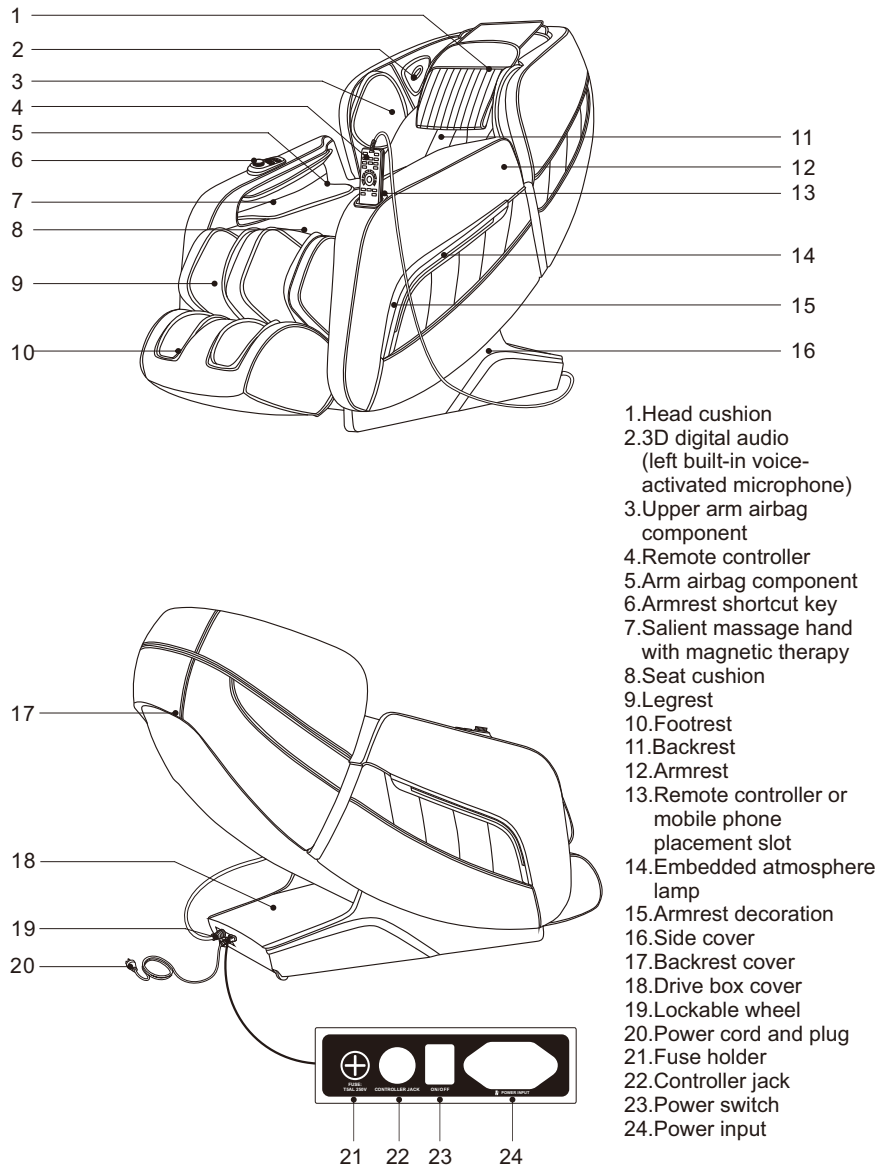

Function

- This product is designed with a set of massage chair manipulators that can move up and down, drive four wheels and operate in mute mode.
- There are five simulative massage techniques: Shiatsu, Kneading, Tapping, Knocking, and simultaneous kneading and Tapping.
- This product is equipped with automatic shoulder detection and positioning.
- This product is equipped with 12 automatic massage functions, including comfort, relax, stretch, shoulder & neck, back & waist, full body massage, chiropractic massage, fatigue recovery, meridians massage, beautiful buttock massage, sleep peacefully massage and full air pressure.
- This product is equipped with the manual massage function for the upper body (the full body, fixed point and local massage parts are selectable; the speed of each massage manipulation can be adjusted with five speed levels. In the fixed point and local mode, the manipulators can adjust the position up and down; during Tapping, Shiatsu and Knocking massage, the width of the massage balls is selectable, i.e. wide, medium or narrow).
- The airbag massage function has three modes (i.e. body pressure, arm pressure, leg pressure) and three levels of intensity for selection.
- This product is equipped with the foot roller massage function.
- At the calf have kneading massage function which can relieve the stiffness and stress of calf.
- The legrest is equipped with a stepless flex adjusting function suitable for users with different heights.
- This product is equipped with the back heat treatment function: carbon fiber is used as far infrared heat source.
- The slide rail technology for the backrest ensures zero space between the backrest and wall, so as to save the space to the greatest extent.
- The backrest guide adopts the curve guide technology, so it completely fits the curve of human back. The full body can enjoy full massage from the head to the thighs.
- The music player system is available. 3D digital audio systems are built into left and right upper arms. The Bluetooth function of the smart device can be used to play music wirelessly.
- This product is equipped with the intelligent voice control and recognition function.
- In the air bags for the left and right palms, there are salient massage bands with magnetic therapy function.
- The right armrest is provided with on/off key, linkage adjustment key, pause/run button, AUTO key, voice control and wake-up button, heat treatment key, air pressure key, Legrest up/down key, zero gravity key, backrest up/down key.
- The right armrest is equipped with USB charging function.
- The armrests on both sides are equipped with LED atmosphere lamps.
- A LCD color screen Remote controller is available.
- After shutdown the chair, it will automatic sitting up, and the manipulator will reset as well.

Method of Usage

Note: Specific display is subject to the actual product!

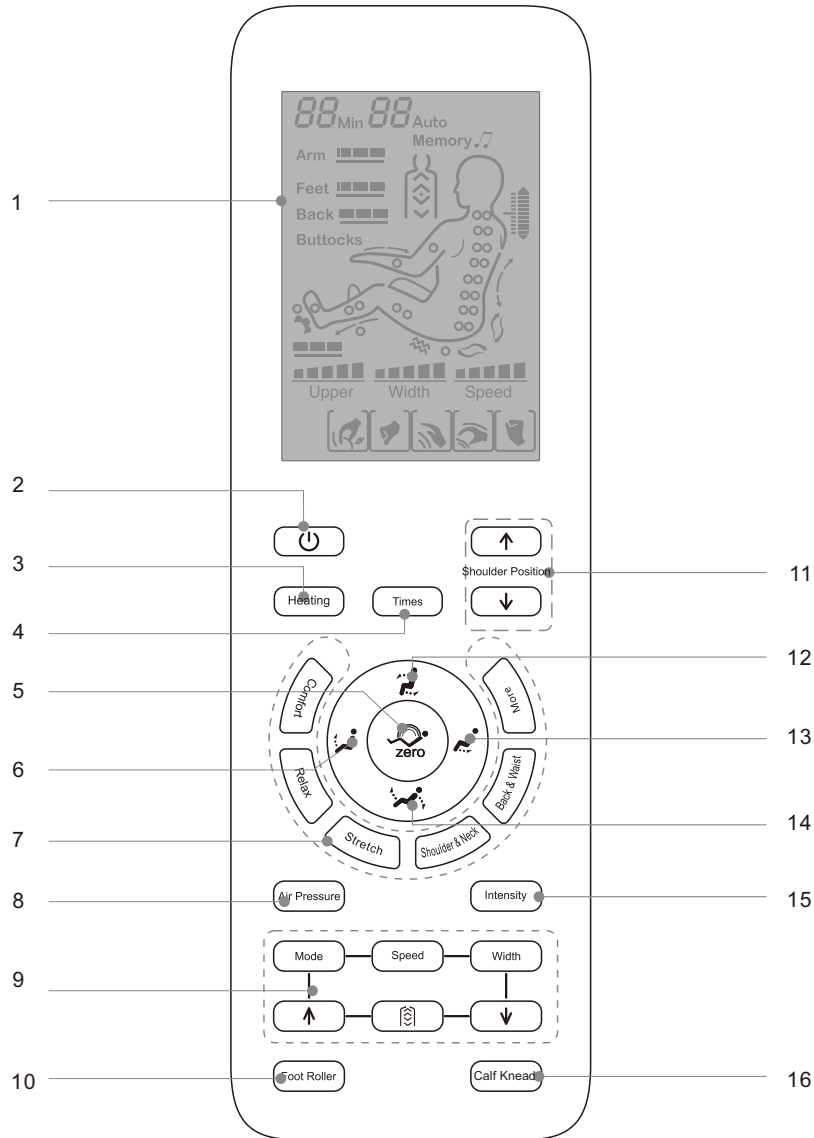

Method of Usage

- 1.LCD:
 - Display all massage functions.
- 2.Power switch:
 - Turn on or off all massage functions.
- 3.Heat key:
 - Turn on/off the heating massage function.
- 4.Timing key:
 - Time setting.Press and hold the button for three seconds to turn off the armrest lamp; operate it again to turn it on.
- 5.Automatic lying key:
 - There are three automatic lying modes, which can automatically switch according to your own needs.
- 6.Legrest up key:
 - Adjust the legrest up function.
- 7.Automatic massage button:
 - Please refer to Page 11 of this manual for details.
- 8.Air pressure mode key:
 - Turn on/off air pressure massage function. (Please refer to Page 12 of this manual for details.)
- 9.Manual massage button:
 - Please refer to Page 12 of this manual for details.
- 10.Foot roller key:
 - Please refer to Page 12 of this manual for details.
- 11.Shoulder adjustment key:
 - Manual adjustment of the shoulder position for Shiatsu massage point.
- 12.Up key:
 - Adjust the backrest up function and the legrest down function.
- 13.Legrest down key:
 - Adjust the legrest down function.
- 14.Lying key:
 - Adjust the backrest down function and the legrest up function.
- 15.Air pressure intensity key:
 - Adjust air pressure intensity function.
- 16.Calf Knead key:
 - Press this button to start or stop the calf rubbing.

Method of Usage

1. Turn on the power supply of this product



2. Start to massage

- ①. Press the power switch to start massage. Start comfort auto massage by default.
- ②. Automatic angle adjustment is performed.
- ③. Automatic shoulder position detection is performed to make sure that the sitting posture fits the massage chair.
- ④. Fine adjustment of the shoulder position: If the detected shoulder position deviates from the actual position, you can press the up/down key for a suitable shoulder position. The shoulder position has 10 adjustable levels. If there is no shoulder position adjustment within 10 seconds, the massage function will start automatically.

Note: In the startup progress, you can select the auto function. If you repeatedly select the same auto function, you can skip the startup process and directly enter the massage mode.

Button	Description	Display
	Move the massage balls upward to a suitable shoulder position.	
	Move the massage balls downward to a suitable shoulder position.	

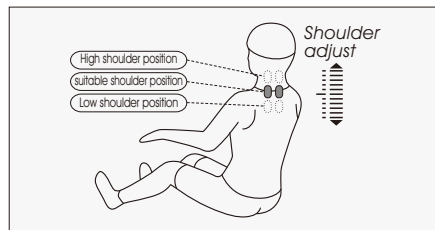

During the detection of the shoulder position for Shiatsu massage point (the shoulder position adjustment icon is displayed on the remote controller screen; when beeps are heard from the remote controller, press the UP/DOWN key for the shoulder position to adjust the shoulder position), you can also choose any one of 12 automatic massage function buttons to enter the massage function (Comfort, Relax, Stretch, Shoulder & Neck, Back & Waist, Full body massage, Chiropractic massage, Fatigue recovery, Meridians massage, Beautiful buttock massage, Sleep peacefully massage and Full air pressure). (You can skip Step 4 directly.)















Method of Usage

· Automatic massage









Function	Button	Description	Display	
Automatic massage		Comfort: The most comfortable massage experience.	F1 Auto	
		Easy: Gentle and comfortable deep massage to relieve your body fatigue and relax the body.	F2 Auto	
		Stretch: Move your body parts up and down through the legrest and the backrest; airbag massage can be performed; and your legs can be.	F3 Auto	
		Shoulder & Neck: Focus on the shoulder and neck massage.	F4 Auto	
		Back & Waist: Focus on the back and waist massage.	F5 Auto	
			Full body massage: Deep massage to rejuvenate your body.	A1 Auto
			Chiropractic massage: Focus on chiropractic massage, and relax your body and mind.	A2 Auto
			Fatigue recovery: Restore the full body from fatigue and pain; achieve relaxation, improve microcirculation, and quickly relieve fatigue for the back and limbs.	A3 Auto
			Meridians massage: Stimulate the circulation of the blood and cause the muscles and joints to relax; quickly improve the body's microcirculation and enhance your immunity.	A4 Auto
			Beautiful buttock massage: Effective massage on the buttocks and thighs to shape the body and reduce the accumulation of excess body fat.	A5 Auto
			Sleep peacefully massage: Through the massage for the twelve major acupoints for healthcare, it helps the body to adjust balance, quickly improve your sleep and sleep quality.	A6 Auto
			Full air pressure: Focus on the full-body airbag massage to achieve full relaxation and deep massage of the body and fully relieve the fatigue and pain from your body.	A7 Auto

Method of Usage



• Manual massage for the upper body

Function	Button	Massage ball adjustment	Display	
Mode		Shiatsu: speed, width		
		Kneading: speed		
		Tapping: speed, width		
		Simultaneous kneading and Tapping: speed, width		
		Knocking: speed, width		
Speed		5 speed levels adjustable		
Width		3 width levels adjustable		
Back stretch		Fixed position massage		
		Local round-trip massage in a small area		
		Complete round trip massage		
		Massage position adjustment (In the fixed point and local modes, the massage position can be adjusted)	Manipulator UP	
			Manipulator DOWN	

• Airbag massage



Function	Button	Description	Display
Air pressure Mode		Full air pressure: airbag massage on the arms, legs and feet.	Arm  Feet 
		Arms: airbag massage on the arms.	Arm 
		Legs: airbag massage on the legs and feet.	Feet 
intensity		Adjustable among three levels.	Arm  Feet 

• Foot roller massage



Function	Button	Description	Display
Foot roller		Press this button to turn on or off the foot roller massage. Three intensity levels (i.e. weak, medium, strong) are adjustable, and switching among four states (i.e. weak, medium, strong, OFF) is available.	

Method of Usage





• Heat massage

Function	Button	Description	Display
Heat		Press this button to turn on or off the Carbon fiber heating treatment on the back. After it is started, heating can be performed within three minutes.	

• Leg knead

Function	Button	Description	Display
Calf Knead		Press this button to start or stop the calf rubbing	

• Lying angle adjustment

Function	Button	Description
Up key		Press this button. The backrest will slowly rise, and the legrest will slowly move downward. Beeps can be heard until it reaches the top. Press this button again during sitting up. Such action will stop immediately.
Lying key		Press this button. The backrest will slowly move downward, and the legrest will slowly rise. Beeps can be heard until it reaches the bottom. Press this button again during lying. Such action will stop immediately.
Legrest up		Press this button. The legrest will slowly rise. Beeps can be heard until it reaches the top. Release this button to stop adjustment.
Legrest down		Press this button. The legrest will slowly move downward. Beeps can be heard until it reaches the bottom. Release this button to stop adjustment.
Automatic lying		Press this button every time to switch to an automatic lying mode. There are three modes in total for switching.

• Other manual functions

Function	Button	Description	Display
Timing		This button is used for time adjustment. After it is pressed every time, the duration will increase by 5 minutes. The total duration cannot exceed 30 minutes; otherwise, such setting will return to the minimum time value.	20min

Method of Usage

3.Introduction to Armrest Shortcut Keys

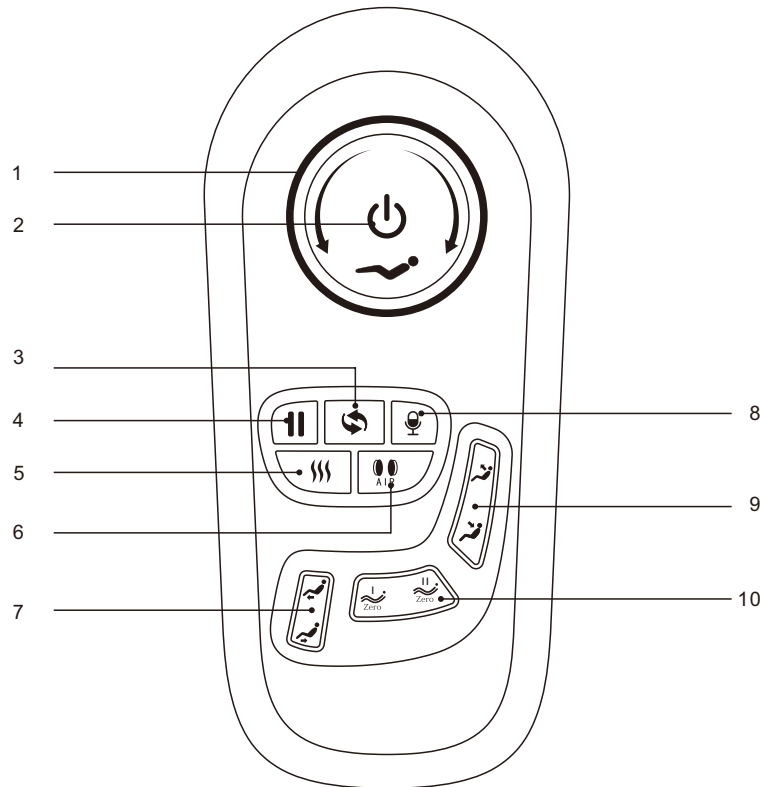

- 1.Linkage adjustment key: press it to perform linkage adjustment on the backrest for upward/downward movement.
- 2.ON/OFF key: press it to start the massage chair.
- 3.AUTO key: press it to enable the automatic massage function. Press and hold the button for three seconds to turn off the armrest lamp; operate it again to turn it on
- 4.Pause/run button: pause or run all massage functions.
- 5.Heat treatment key: click the key to enable or disable the heat treatment function.
- 6.Air pressure key: turn on/off air pressure massage function.
- 7.Legrest up/down key: press it to make the legrest move upward/downward.
- 8.Voice control and wake-up button: Short press to enable the voice control function, long press 3 seconds to turn on or off the voice control function.
- 9.Backrest up/down key: press it to make the backrest move upward/downward.
- 10.Zero-gravity key: press it to adjust the massage chair to the angle for zero gravity.

Method of Usage

Function	Description
	Power button: Short press this button to pause the operation; if it is hold down for 3 seconds, power will be ON/OFF. If the pause time during massage exceeds 20 minutes, all the massage functions will be automatically turned off.
	Linkage lying knob: By rotating this knob clockwise, the backrest will move downward slowly and the legrest will rise slowly; by releasing it, such DOWN/UP action of the backrest and the legrest will be stopped. Linkage sitting knob: By rotating this knob counterclockwise, the backrest will rise slowly and the legrest will move downward slowly; by releasing it, such UP/DOWN action of the backrest and the legrest will be stopped.
	Press this button during massage, and all the massage actions will be suspended at once. (i.e. the massage chair will turn off after 20min). Then press this button again to restore all the previous massage actions.
	Automatic mode key: Press it to switch among those automatic massage functions. Press and hold the button for three seconds to turn off the armrest lamp; operate it again to turn it on
	Voice control and wake-up button: Short press to enable the voice control function, long press 3 seconds to turn on or off the voice control function.
	Heat treatment key: Click the key to enable or disable the heat treatment function.
	Air pressure key: Turn on/off air pressure massage function.
	Legrest up button: Pull the button to make the legrest rise slowly. Release it to stop such action.
	Legrest down button: Press the button to make the legrest move downward slowly. Release it to stop such action.
	Zero-gravity key I : the positions of the legrest and the backrest can be automatically adjusted to the positions I for zero gravity.
	Zero-gravity key II : the positions of the legrest and the backrest can be automatically adjusted to the positions II for zero gravity.
	Backrest up button: the back rest keeping lifting when pressing this button, and black rest stopped lifting once release the button.
	Backrest down button: the back rest keeping reclining when pressing this button, and black rest stopped reclining once release the button

Method of Usage

4.Voice Control Mode

- When the massage chair is turned on or in standby mode, the sound "Hi Alice" or "Hey Alice" will be produced to enable the voice control function. Alternatively, you can press the voice control button on the right armrest to enable the voice control function.
- Long press 3 seconds to turn on or off the voice control function.
- After such function is enabled successfully, the massage chair will reply "I am here." At this moment, once a corresponding voice control entry to be implemented is given within six seconds, the corresponding voice control function can be performed after a reply is received from the massage chair; if no correct voice control entry is given within six seconds, the voice control function automatically will be off automatically and needs to be enabled again.
- Note: When waking up the voice control function, please use English, the speech rate is moderate, Voice commands should be follow up the Voice entry.

Voice Control Entry		
Entry: "Hi Alice" or "Hey Alice". Answer: I am here.		
No.	Voice control entry	Answer entry
1	Massage on	Answer: Ok, massage on
2	Massage close	Answer: Ok, massage close
3	Comfort Massage	Answer: Ok, comfort massage
4	Relax massage	Answer: Ok, relax massage
5	Full body massage	Answer: Ok, full body massage
6	Neck and shoulder massage	Answer: Ok, neck and shoulder massage
7	Back and waist massage	Answer: Ok, back and waist massage
8	Stretch massage	Answer: Ok, stretch massage
9	Open the air pressure	Answer: Ok, open the air pressure
10	Close the air pressure	Answer: Ok, close the air pressure
11	Up the seat position	Answer: Ok, up the seat position
12	Down the seat position	Answer: Ok, down the seat position
13	Change the other mode	Answer: Ok, change the other mode
14	Go little down	Answer: Ok, go little down
15	Go little up	Answer: Ok, go little up

Note: commands 14 and 15 can only be used after command 13.

Method of Usage

5.Operation Instructions for Bluetooth Speaker Play

- 1.Enter the smart device main menu. Open "Settings" and select the "Bluetooth" option. Open "Bluetooth", and Bluetooth will automatically "Search for a New Bluetooth Device".
- 2.The smart device will search for the corresponding Bluetooth model (e.g. IMCM-XXXX). Click the "Match" button. If you are asked whether to match with the device, you just select "Match" to complete matching.
- 3.Turn on "Music Player" in the smart device and select the song to play.

6.Turn off the power and stop massage

- If the power button is pressed during massage, it will stop all the massage functions immediately, and the backrest, the legrest and massage chair manipulators will go back to the default positions. When the preset massage time is up, all the massage functions will be OFF. The backrest and the legrest will not go back to the default positions.
- Shut off the power supply of this product, as shown in the attached figure (Power Shut-off Diagram of the Product).



7.Installation Instructions for Legrest

- After connecting the wires and the air hose between the legrest and the massage chair, remove the cable ties and insert the connecting part into the seat (Figure 1).
- Place the round tubes on the left and right sides of the legrest onto the legrest support (Figure 2).

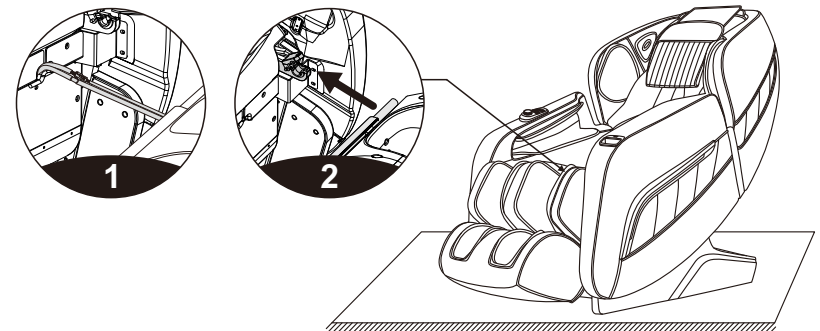

Method of Usage

- Next, turn the legrest fixing cover over to cover the round tubes on both sides of the legrest (Figure 3).
- Fasten the legrest to the massage chair with two M4 screws (one on each side). Check whether there is any abnormality during turning up and down, or any tube, cable or wire is folded. If everything is OK, the legrest is installed (Figure 4).

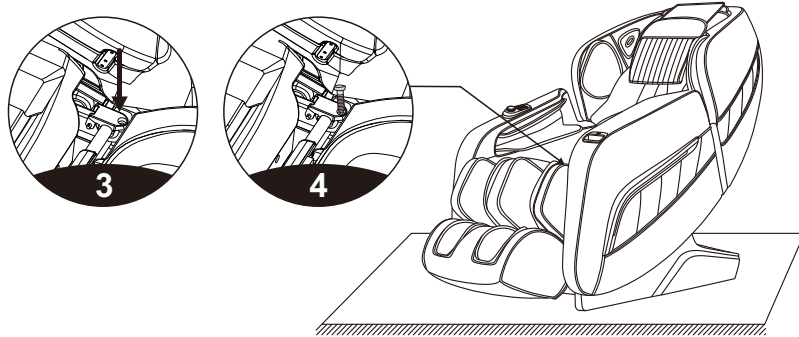

8. Instructions for Removal and Use of Head Cushion and Backrest

- The use of the head cushion can reduce the intensity of kneading massage on the neck and shoulders. You can decide whether to use the head cushion according to your own needs (the head cushion is recommended). The backrest and the back cushion are connected by a zipper (1). The head cushion and the backrest are connected by a zipper (2).

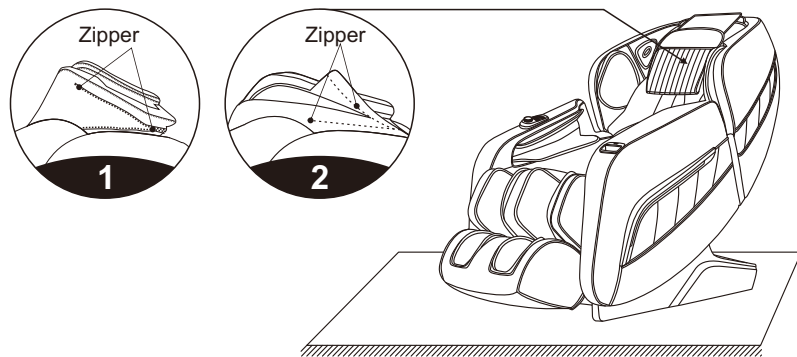

Method of Usage

9. Floor Protection

- The prolonged heavy pressure on the massage chair may cause scratches on the floor. Thus, put a carpet or cushion on the floor where the massage chair is placed to avoid this damage.

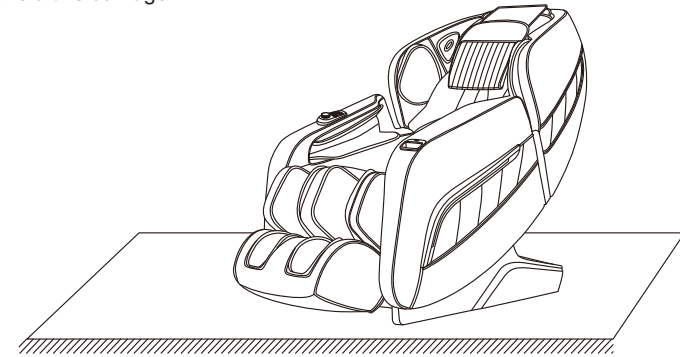

Note: Do not move the massage chair with its wheels on the rough ground or in a narrow space. At least two persons are required to lift it. During lifting, take the legrest sealing plate and backrest cover grooves as the acting points. (Do not lift the armrest directly.)

10. Instruction for Movement

- Make sure that all the wires are pulled away from the massage chair surface; then press the backrest down to a certain angle (with the center of gravity resting on the wheels), you can push the massage chair forward with hands, move it to a suitable position and gently restore it to the normal angle. (Note: During movement, you must turn off the power button first and then unplug the power cord and the remote controller connection wire.)

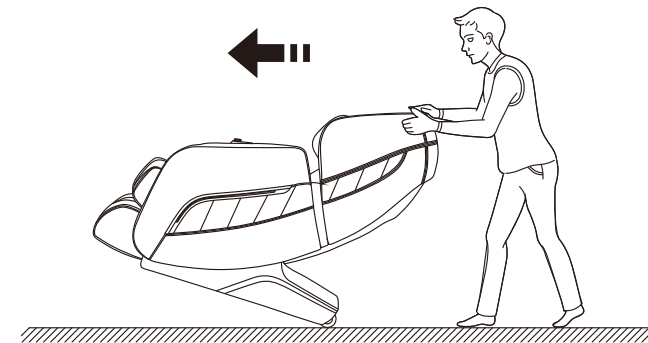

Warning : The rear moving wheels of the massage chair are only suitable for short-distance and slow movement. For long-distance transportation, please use other auxiliary moving tools to move this massage chair!

Legal notices

FCC Information

- Any changes or modifications not expressly approved by the party responsible for compliance could void the user's authority to operate the equipment.
- This device complies with Part 15 of the FCC Rules. Operation is subject to the following two conditions:
 - (1) this device may not cause harmful interference, and
 - (2) this device must accept any interference received, including interference that may cause undesired operation.
- This equipment has been tested and found to comply with the limits for a Class B digital device, pursuant to Part 15 of the FCC Rules. These limits are designed to provide reasonable protection against harmful interference in a residential installation. This equipment generates, uses, and can radiate radio frequency energy, and if not installed and used in accordance with the instructions, may cause harmful interference to radio communications. However, there is no guarantee that interference will not occur in a particular installation. If this equipment does cause harmful interference to radio or television reception, which can be determined by turning the equipment off and on, the user is encouraged to try to correct the interference by one or more of the following measures:
 - Reorient or relocate the receiving antenna.
 - Increase the separation between the equipment and receiver.
 - Connect the equipment into an outlet on a circuit different from that to which the receiver is connected.
 - Consult the dealer or an experienced radio/TV technician for help.

This equipment complies with FCC radiation exposure limits set forth for an uncontrolled environment. This equipment should be installed and operated with a minimum distance of 20cm between the radiator & your body. This transmitter must not be co-located or operating in conjunction with any other antenna or transmitter.

Product Specification

Model: A306

Configure: 28

Name: Massage Chair

Rated voltage: 110-120V~ 60Hz
220-240V~ 50Hz/60Hz

Rated power: 150W

Rated time: 20Min

Safety structure: Class I

Material description: PVC, PA, steel parts, electric and electron components

MATERIAL	PU	LEATHER	CLOTH	WOOD