

## A303 MASSAGE CHAIR

OPERATION INSTRUCTIONS

**SAVE THESE INSTRUCTIONS**

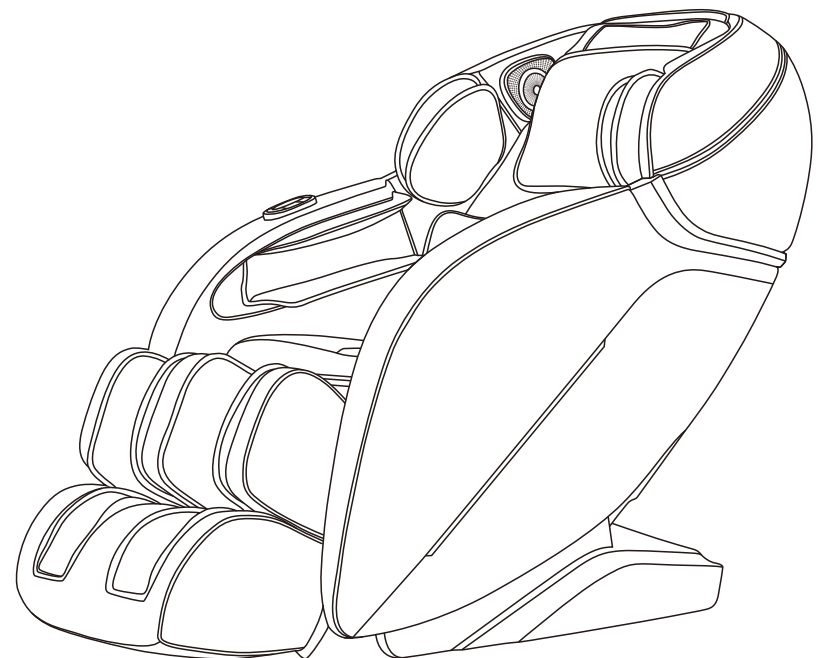

Thanks for purchasing this product. Please read this manual instruction carefully in order to know how to use this product correctly before operation. Please pay more attention to some important safety warning and keep this manual book properly for future use.

Note: Our company reserves the right to change and explain the design of the product. If there is some difference between the product function in market circulation and the description in the manual, it is a normal update of the product, and our company will not inform you otherwise. The specific product function and color shall prevail in kind.

## **TABLE OF CONTENTS**

---

Safety and Maintenance	02
Safety Warning	04
Names of Components	06
Function	07
Method of Usage	08
Legal notices	19
Product Specification	19

## Safety and maintenance

---

### 1. Important Safety Warnings



- Do not allow children to touch any movable part of this product.
- Use the well-grounded power supply unit suitable for this product.
- Pull out the plug after use or before cleaning to avoid any physical injury or damage to the product.
- Operate this product as instructed in this manual.
- Do not use any parts or accessories which are not recommended.
- Do not use this product outdoors.
- Please read the Operation Instructions carefully before operation.
- Never use this product for any other purpose not listed herein.
- 20 minutes of usage each time is recommended.
- Do not use this product if the leather is broken or damaged.
- Do not use this product if the cover or leather is broken or damaged.
- Do not use this product if the radiator hole is covered or blocked.
- Do not drop anything into this product.
- Never fall asleep while using this product.
- Do not use this product if you are drunk or feel unwell.
- Do not use this product within one hour after a meal.
- Do not use this product with excessive force to avoid any injury.
- Do not carry any fragile, explosive, or combustible material in your pocket, such as a mobile phone and lighter when using the massage chair.

### 2. Operating Environment

- Do not use this product in a very moist environment such as the bathroom.
- Stop using this product immediately when the ambient temperature changes sharply.
- Do not use this product in any heavily-dusty or caustic environment.
- Do not use this product in a small space or a place without good ventilation.
- The normal room temperature ranges from 0 °C to 35 °C.
- Do not use this product in an excessively humid room such as a bathroom. Use it at a relative humidity between 20% and 80%.
- Do not use this product outdoors.
- Avoid direct sunlight.
- Keep this product away from any heat source such as a stove and air outlet of an air conditioner.
- Do not use this product during thunder or lightning weather.
- Do not use this product in dusty places.

### 3. The following populations should not use this product:

- Patients with osteoporosis.
- Patients with heart disease or wearing electronic medical devices such as a pacemaker.
- People who have a fever.
- Pregnant women or women on their menstrual period.
- Patients who are injured or have a skin disease.
- When unsupervised, any children are under the age of 14 and those unconscious are not allowed to use this product.
- People who are told by their physicians to have rest or who feel unwell.
- People whose bodies are wet are forbidden to use this product.
- This product has a hot surface. Persons insensitive to heat must pay attention when using this product.

## Safety and maintenance

---

### 4. Safety Precautions

- Check whether voltage is consistent with the specification of this product.
- Never insert or pull out the plug with a wet hand.
- Do not let water flow into this product to avoid electric shock or cause damage to this product.
- Do not pull the power cord when plugging or unplugging it. Rough handling is forbidden.
- Do not damage the wire or modify the circuit of this product.
- Do not clean live parts of this product with a wet cloth such as a power switch and plug.
- Be away from this product in case of power failure to avoid any injury if power is restored suddenly.
- Stop using this product at once while it works abnormal, and consult your local supplier.
- Stop using this product if you feel unwell, and consult your health care practitioner.
- This product is not intended for use by persons (including children) with reduced physical, sensory or mental capabilities, or lack of experience and knowledge, unless they have been given supervision or instruction concerning the use of this product by the personnel responsible for their safety. Children should be supervised to ensure that they do not play with this product.
- If the power cord is damaged, it must be replaced by the manufacturer, its service agent or similarly qualified staff in order to avoid hazards.

### 5. Product Service and Maintenance

- This product should be maintained by the service center designated by the manufacturer only. No user should disassemble or maintain it without permission.
- Do not forget to turn off the main power switch after usage.
- Do not use this product if the power socket becomes loose.
- If this product will be left unused for a long period of time, it is necessary to roll up the power cord of this product and store this product in a dry and dust-free environment.
- Do not store this product at a high temperature or near open flame. Avoid prolonged exposure to direct sunshine.
- Please clean this product with dry cloth. Never use thinner, benzene or alcohol.
- The mechanical components of this product are specially designed and manufactured, so no special maintenance is needed.
- Do not use a sharp object to stab at this product.
- Do not roll or pull this product on any uneven ground. Instead, it should be lifted before moving.
- Please use this product intermittently. Do not keep it working continuously for a long period of time.

### 6. Solutions to Ordinary Malfunctions

- If the motor sounds during operation of this product, this is the normal operation sound.
- If the controller cannot work normally, check whether the plug and the power socket are connected reliably, and whether the power switch is turned on.
- If the rated working time is over, this product will automatically activate the power-off button; If this product keeps operating for a long period of time, the temperature protector will stop this product automatically. The product can be used again after half an hour.

### 7. Storage Conditions

- Storage room temperature: -5 °C to 35 °C.
- Relative humidity (RH) between 20% and 80%; free of corrosive gases, and a well-ventilated room.

## Safety warning

### ⚠ Warning

When the legrest of the massage chair is lifted, nobody should apply pressure on the legrest to prevent the massage chair from falling forward which will damage this product or result in personal injuries.

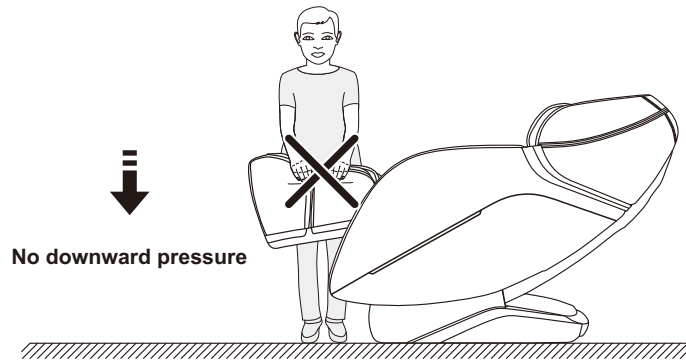

### ⚠ Warning

Before sitting on the massage chair, make sure that the massage chair manipulator does not stay in the seat cushion position to avoid discomfort to the buttocks during the body pressing down and any damage to the massage chair manipulator.

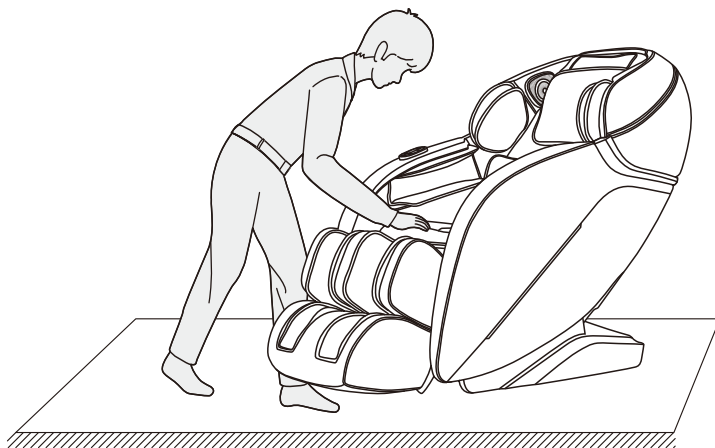

## Safety warning

### ⚠ Warning

Do not remove or pull out the remote controller cable or the power cord in the standby or power-on state to avoid any damage to this product or accidental electric shock of a body part. You are advised to unplug the remote controller cable and the power cord and put them away after you use the massage chair.

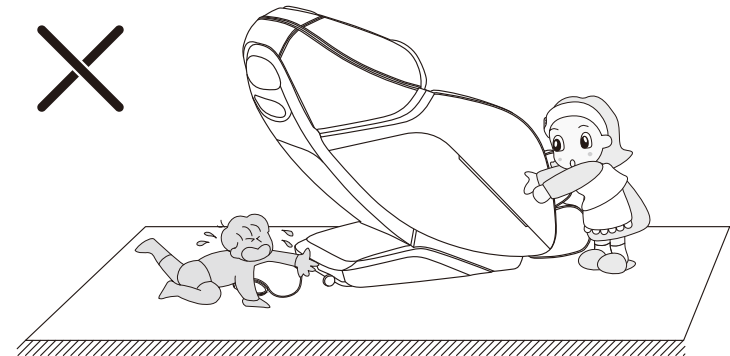

### ⚠ Warning

When the zero-gravity lying function is enabled, be sure to check whether there is any child or pet staying or playing under the bottom of the legrest and backrest, in order to avoid any damage to this product or physical injury.

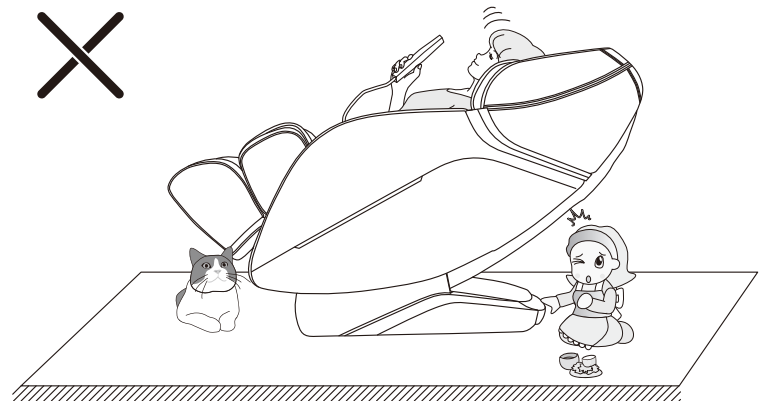

## Name of components

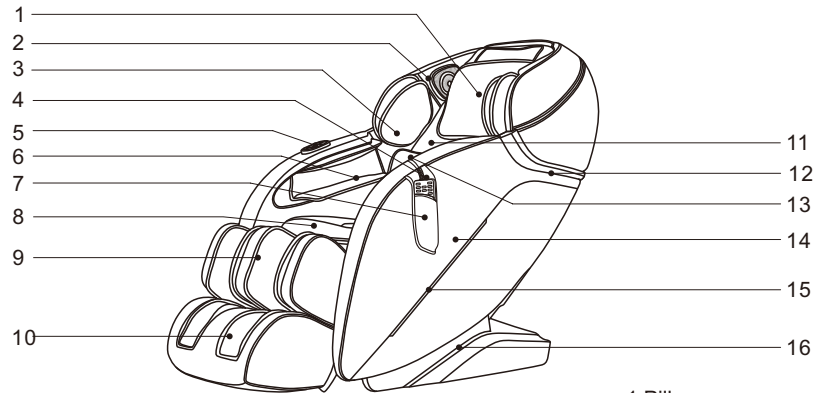

- 1.Pillow
- 2.3D Audio Speakers(Built-in voice microphone on the left side)
- 3.Upper arm airbags component

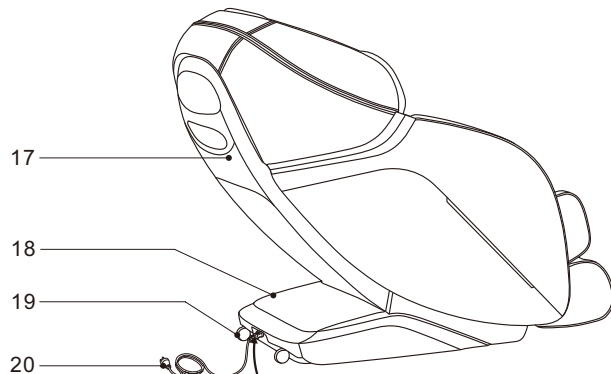

- 4.Remote
- 5.Armrest shortcut key
- 6.Arm airbags component
- 7.Remote bag
- 8.Seat cushion
- 9.Calf frame
- 10.Foot frame
- 11.Back cushion
- 12.Armrest decoration
- 13.Waist airbag component
- 14.Armrest
- 15.LED Lights
- 16.Side cover



- 17.Back cover
- 18.PCB box cover
- 19.Caster
- 20.Power cord and plug
- 21.Fuse box
- 22.Remote wire plug
- 23.Power cord socket

## Function

- Designed with a set of vertically movable, four wheel driven muted intelligent massage hands.
- There are five kinds of simulated massage techniques: shiatsu, kneading, tapping, knocking, kneading & tapping.
- Set with eight kinds of characterized auto massage function: comfort, relax, energy, waist & buttock, shoulder&neck, stretch, fatigue recovery, hip care.
- It has the upper body manual massage function (area, fixed point, full back, upper body, lower body, five massage parts selection, each massage technique speed can be adjusted in three steps. In the fixed point and partial module state, the massage ball can move up and down to adjust the massage point accurately. In the state of tapping, shiatsu and knocking massage, the width between the two kneading balls is adjustable with three levels: wide, medium and narrow.
- Air pressure massage function with three modes: Full body air pressure, arms air pressure, leg air pressure, with 3intensity adjustable.
- Twisting massage, waist airbag massage to take care for the health of the waist
- Combined with human back curve technology, makes you enjoy personal massage from the head to the leg.
- The audio speakers are located on the upper arm area of the product, music can be played by connecting the blue tooth to a smart phone or tablet device.
- With sole roller massage function.
- The back heating function use carbon fiber as an infrared heating source.
- The footrest can be extended to suit different leg lengths.
- The motor drives the footrest and the backrest synchronically and lay down automatically two regulatory functions.
- The backrest of the massage chair should be kept at least 275 mm away from the wall.
- The right armrest is provided with on/off key, AUTO key, zero gravity key, linkage lying key, linkage sitting key.
- Natural magnet is placed at the heel of footrest.
- Design with LED light on each side of the armrest.
- LCD colorful screen remote controller.
- The chair will be reset when switch off. The massage hands will be restore as well.

## Method of usage

**Note: The specific displays refer to the actual object of this product!**

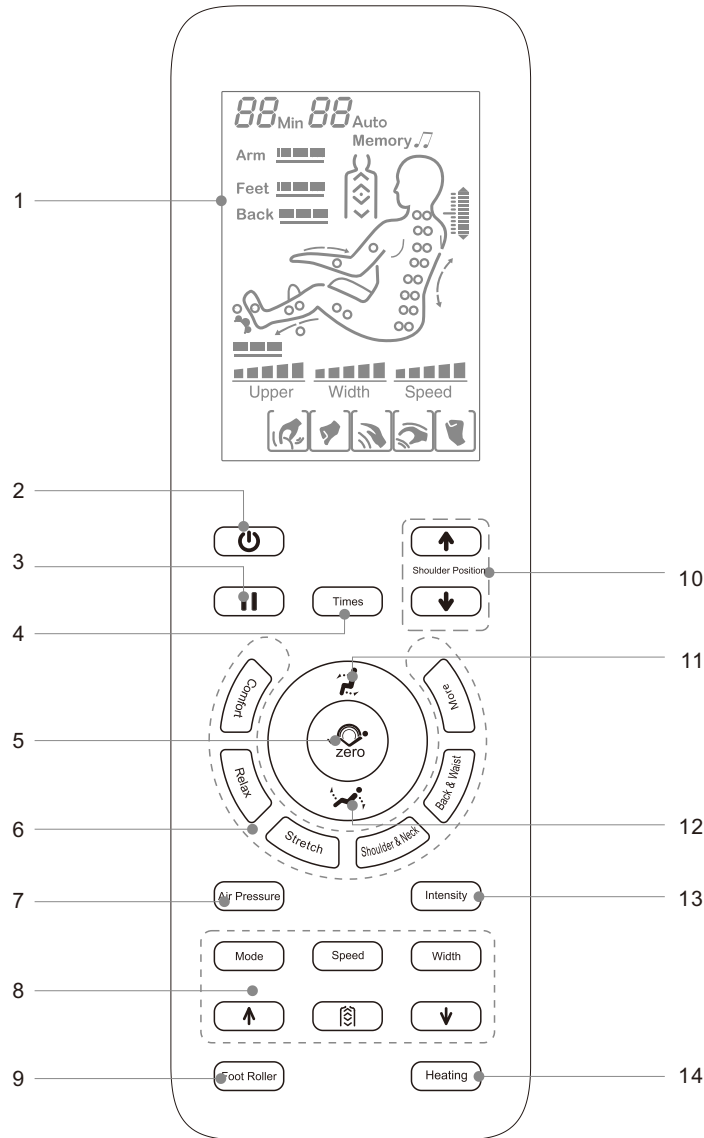

## Method of usage

- 1.LCD display:
  - Display all massage functions
- 2.Power switch:
  - Turn on or Turn off all massage functions.
- 3.Pause button:
  - Stop or start all massage functions.
- 4.Timing button
  - Time setting.Press and hold the button for three seconds to turn off the armrest lamp; operate it again to turn it on.
- 5.Auto lying Button
  - There are three automatic lying position, choose your favorite one.
- 6.Auto massage Button
  - Please refer to page 11 of this manual for details.
- 7.Air pressure mode Button
  - Turn on/off the air pressure massage function (refer to page 12 of this manual for details).
- 8.Manual massage button
  - Please refer to page 11 of this manual for details.
- 9.Sole roller button
  - Turn on/off sole roller massage function
- 10.Shoulder adjust button
  - Make the adjustment on shoulder acupressure points.
- 11.Lifting button
  - Rise up the backrest and lower down the footrest.
- 12.Lying button
  - Lower down the backrest and rise up the footrest.
- 13.Air pressure intensity button
  - Make the adjustment on air pressure intensity.
- 14.Heating
  - Turn on/off heating massage function

## Method of usage

### 1. Switch power supply on

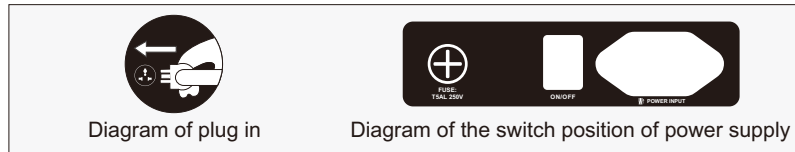

### 2. Start to massage

- ①. Press the power button to start massage.
- ②. The chair conduct a body scan and testing your shoulder position and massage point, waiting for detection to be completed
- ③. If the body scan deviates from the actual shoulder position, adjust the up and down buttons to the appropriate position. There are 10 levels to adjust, and you have 10 seconds to make the adjustment. After 10 seconds, enter in to massage automatically.

Button	Description	Display
	Move the massage balls upward to a suitable position	
	Move the massage balls downward to a suitable position	

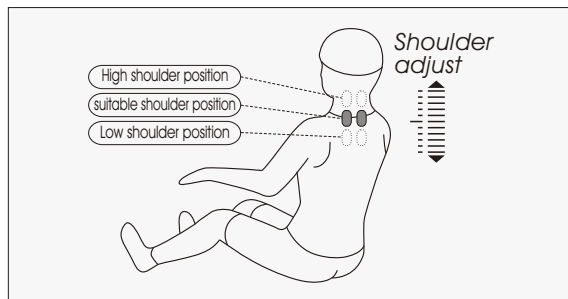

During the body scan process (the shoulder position adjustment icon will be displayed on the screen of the controller and sounds "DiDi", and then press the shoulder position up and down keys to adjust the shoulder position). You can also press any of the six automatic massage function keys (comfort, ease, full body, neck shoulder, back waist, stretch) and start massage (you can skip step 4 directly).

- ④. Choose massage function and start massage

## Method of usage









### · Features automatics massage

Function	Button	Description	Display
Features automatics massage		Loosen the muscles.	F1 Auto
		Deep-tissue massage throughout key acupressure points to relax the sore area.	F2 Auto
		Stretch: Move your body parts up and down through the legrest and the backrest; airbag massage can be performed; and your legs can be.	F3 Auto
		Focus on the neck and shoulder area	F4 Auto
		Focus on the back waist area.	F5 Auto
		Energy: The footrest and backrest lifting together, combined with air ressure massage to stretch the legs, remove fatigue, and recover your body.	F6 Auto
		Fatigue recovery : Improve fatigue and soreness of the whole body, and target the back and limbs to relax and improve the microcirculation	F7 Auto
		Hip care :Massage effectively the buttocks and thighs for body shaping	F8 Auto









### · Upper body manual massage

Function	Button	Massage ball adjustment	Display
Massage		Shiatsu Speed, width	
		Kneading: Speed	
		Tapping: Speed, width	
		Kneading and tapping: speed	
		Knocking: Speed, width	
Speed		3 adjustable level	
Width		3 adjustable level	



## Method of usage

Back stretch		The massage hand stay in fixed position		 H0
		The massage hand will move up and down in a partial position		 H1
		The massage hand will move up and down on full back		 H2
		The massage hand will move up and down on back and shoulder area		 H3
		The massage hand will move up and down on back and waist area		 H4
		Message position adjustment (in fixed point, partial mode, the message position can be adjusted).	Message hand move up	
	Message hands go down			



### • Air pressure massage

Function	Button	Description	Display
Air pressure mode		Full air pressure: air pressure massage on arm, leg and foot.	Arm  Feet 
		Arm: Air pressure massage focus on arm.	Arm 
		Legs: Air pressure massage focus on leg and foot.	Feet 
Intensity		3 levels adjustable	Arm  Feet 

### • Foot roller manual massage function



Function	Button	Description	Display
Foot roller		The foot roller massage function turn on or off.	

### • Heating



Function	Button	Description	Display
Heating		Press this button to turn on/off the back infrared heating, and it will be warm after turning on 3 minutes.	

## Method of usage

### • Pause/start message button

Function	Button	Description	Display
Pause/Start		Press this button during the massage, all massage actions are stop immediately (the timer will continue to count down), and press this button again, all the massage will be resume.	

### • Backrest and calf position adjust

Function	Button	Description
Lifting button		Press and hold this button, it will raise the backrest and lower the footrest simultaneously, a "Di.Di" sound indicate that it has reach the maximum position and stop. Press this button again while lifting, then immediately stop.
Lying button		Press and hold this button, it will lower the backrest and raise the footrest simultaneously, a "Di.Di" sound indicate that it has reach the maximum position and stop. Press this button again while lifting, then immediately stop.
Automatic lying mode		Switch to an auto lying mode when you press key each time, total 3 modes, cycle switching change. Long press the zero gravity button of remote controller for 3 seconds to turn on or off voice control function.

### • Other manual functions

Function	Button	Description	Display
Timing		Timing adjustment, press one time, add 5 minutes, not more than 30 minutes. If it exceeds 30 minutes, it will return to 5 minutes.	20 min



## Method of usage

### 3.Introduction to Armrest Shortcut Keys

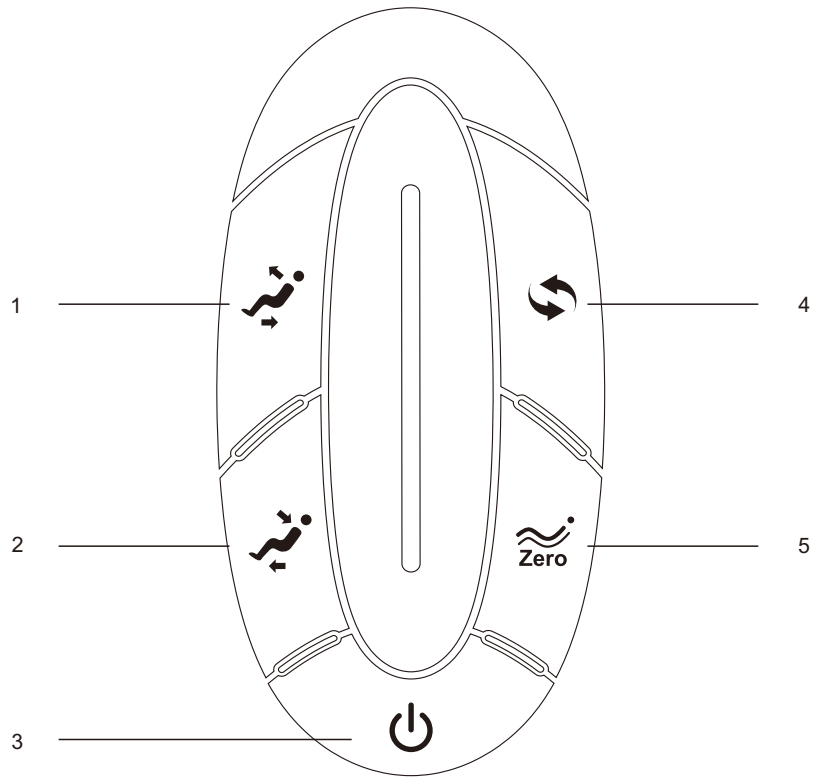

1. Linkage sitting key: Adjust the linkage sitting angle.
2. Linkage lying key: Adjust the linkage lying angle.
- 3.ON/OFF key: Press it to start the massage chair.
4. AUTO key: Press it to enable the automatic massage function.
- 5.Zero-gravity key: Press it to adjust the massage chair to the angle for zero gravity.

## Method of usage

Function	Description
	Linkage sitting key: By holding down this key, the backrest will rise slowly and the leg rest will move downward slowly; by releasing it, such UP/DOWN action of the backrest and the leg rest will be stopped.
	Linkage lying key: By holding down this key, the backrest will move downward slowly and the leg rest will rise slowly; by releasing it, such DOWN/UP action of the backrest and the leg rest will be stopped.
	Power button: Short press this button to turn ON/OFF the massage.
	Automatic mode key: Press it to switch among those automatic massage functions.
	Zero-gravity key: After this key is pressed, the positions of the legrest and the backrest can be automatically adjusted to the positions for zero gravity. There are three levels of zero-gravity lying modes, which can be switched.

### 4.Turn off the power and stop massage.

- When pressing the power button during the massage, it will stop all the massage functions immediately, the backrest and footrest will go back to the default posit on.And when the massage time up, the massage hand will go back to the default position, all the massage function will stop, the backrest and footrest will not go back to the default position.
- Cut off the power of the whole machine. Figure (switch power off)



## Method of usage

### 5.The calf installation.

- After connecting the wires and the air hose between the chair seat and the leg rest , unfasten the fixed pipe belt and insert the connecting part into the seat frame (figure 1).
- Place the round tube from calf left and right sides to the legs brackets.(figure 2)

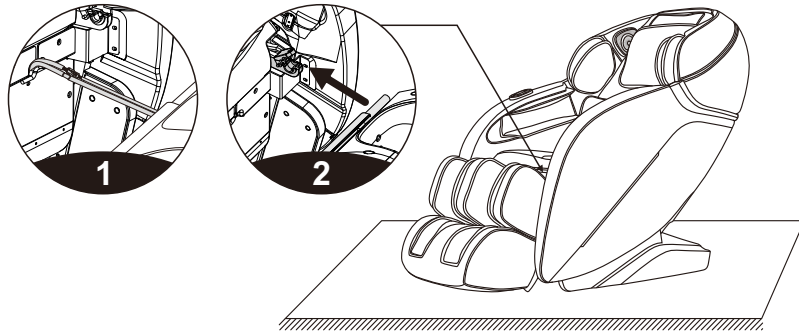

- Then turn the legs fixing cover over the round tube on both sides of the legs (figure 3)
- Then use 2pcs M4 screws fix the legs on the massage chair, turn up and down to check if there are any problems, the wires and air hose get stuck or not, finish the installation. (figure 4)

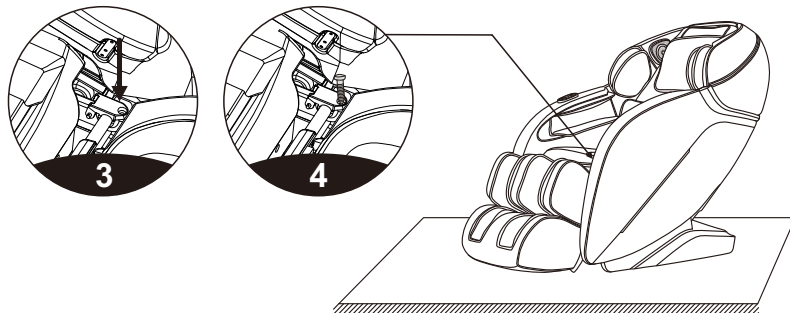

## Method of usage

### 6.Head cushions and backrest pad's dismounting and use manual

- The head cushion allows you to control the intensity of the neck and shoulder massage. You can decide whether to use the head cushion (Recommend to use). The backrest cushion and the backrest is connected by zipper (1), head cushion and the backrest cushion connected by the Velcro as show in the illustration (2).

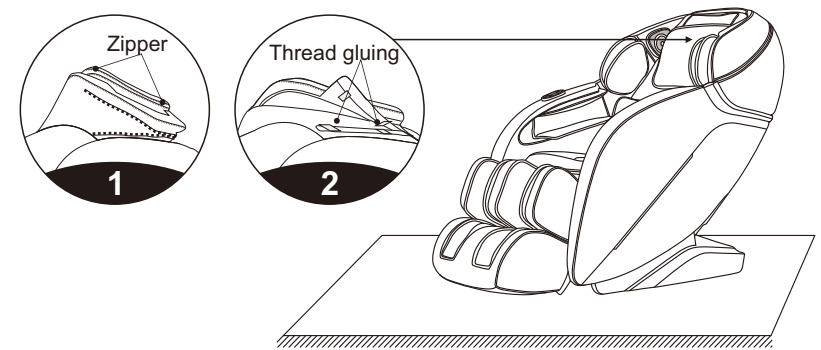

### 7.Floor Protection

- The prolonged heavy pressure on the massage chair may cause scratches on the floor. Thus, put a carpet or cushion on the floor where the massage chair is placed to avoid this damage.

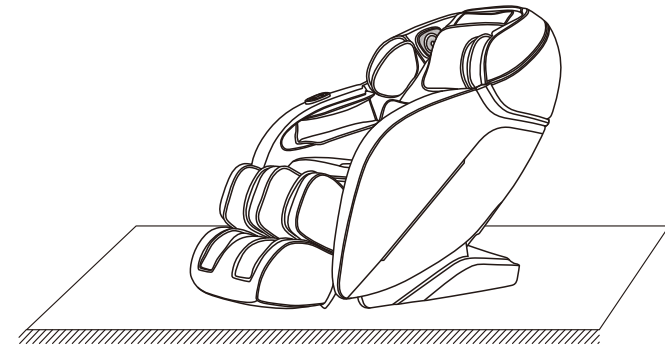

Note: Do not move the massage chair with its wheels on the rough ground or in a narrow space. At least two persons are required to lift it. During lifting, take the legrest sealing plate and backrest cover grooves as the acting points. (Do not lift the armrest directly.)

## Method of usage

### 8. Instruction for Movement

- Make sure that all the wires are pulled away from the massage chair surface; then press the backrest down to a certain angle (with the center of gravity resting on the wheels), you can push the massage chair forward with hands, move it to a suitable position and gently restore it to the normal angle. (Note: During movement, you must turn off the power button first and then unplug the power cord and the remote controller connection wire.)

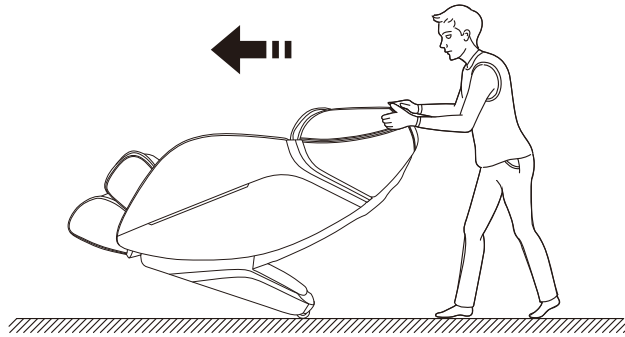

Warning : The rear moving wheels of the massage chair are only suitable for short-distance and slow movement. For long-distance transportation, please use other auxiliary moving tools to move this massage chair!

### 9. The distance from the wall

- When you place the massage chair, the backrest should always be kept at least 275mm away from the wall. If the backrest is too close to the wall, it will collide the wall and cause damage to the product when it lifting down.

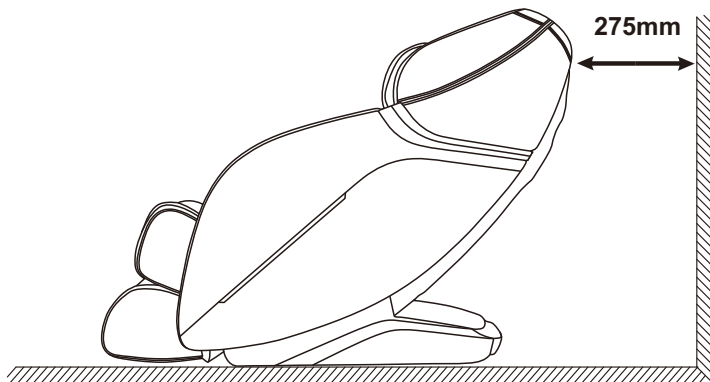

## Legal notices

### FCC Information

- Any changes or modifications not expressly approved by the party responsible for compliance could void the user's authority to operate the equipment.
- This device complies with Part 15 of the FCC Rules. Operation is subject to the following two conditions:
  - this device may not cause harmful interference, and
  - this device must accept any interference received, including interference that may cause undesired operation.
- This equipment has been tested and found to comply with the limits for a Class B digital device, pursuant to Part 15 of the FCC Rules. These limits are designed to provide reasonable protection against harmful interference in a residential installation. This equipment generates, uses, and can radiate radio frequency energy, and if not installed and used in accordance with the instructions, may cause harmful interference to radio communications. However, there is no guarantee that interference will not occur in a particular installation. If this equipment does cause harmful interference to radio or television reception, which can be determined by turning the equipment off and on, the user is encouraged to try to correct the interference by one or more of the following measures:
  - Reorient or relocate the receiving antenna.
  - Increase the separation between the equipment and receiver.
  - Connect the equipment into an outlet on a circuit different from that to which the receiver is connected.
  - Consult the dealer or an experienced radio/TV technician for help.

This equipment complies with FCC radiation exposure limits set forth for an uncontrolled environment. This equipment should be installed and operated with a minimum distance of 20cm between the radiator & your body. This transmitter must not be co-located or operating in conjunction with any other antenna or transmitter.

## Product specification

Model: SL-A303

Configure: 11

Name: Massage Chair

Rated voltage: 110-120V~ 60Hz   
220-240V~ 50Hz/60Hz

Rated power input: 120W

Rated time: 20Min

Safety structure: Class I

Material introduction: PVC, PA, steel parts and electric & electron parts

MATERIAL	PU	LEATHER	CLOTH	WOOD